

**ZANUSSI**



**ELECTRIC  
DOUBLE OVEN  
AND GRILL WITH  
GAS HOB  
ZCM 8021**

**INSTRUCTION BOOKLET**

## IMPORTANT SAFETY INFORMATION

These warnings are provided in the interests of your safety. Ensure that you understand them all before installing or using the appliance. Your safety is of paramount importance. If you are unsure about any of the information in this book contact the Customer Care Department. Telephone 0870 5 727727.

### INSTALLATION

- The appliance must be installed according to the instructions supplied. The installation work must be undertaken by a competent person as stated in the Gas Safety (Installation & Use) Regulations Current Edition. For appliances installed in the Republic of Ireland please refer to NSAI - Domestic Gas installation IS813 Current Editions.
- This appliance should be serviced by an authorised Service Engineer and only genuine approved spare parts should be used.
- It is important that the appliance is suitable for your gas supply. Your installer should check the rating plate.
- The appliance must be installed in an adequately ventilated room.
- This appliance is heavy and care must be taken when moving it. **Do not** try to *lift* or move the appliance by pulling the door handles.
- If the appliance is to be placed on a base, measures must be taken to prevent the appliance from slipping.
- All packaging, both inside and outside the appliance must be removed before the appliance is used.
- **Do not** allow children to play with any part of the packaging.
- It is dangerous to alter the specifications or modify the appliance in any way.

### CHILD SAFETY

- This appliance is designed to be operated by adults. Young children **must not** be allowed to tamper with the controls or play near or with the appliance.
- During use the appliance becomes **Hot**. Care should be taken to avoid touching the heating elements inside the appliance.
- **CAUTION: Accessible parts may be hot when the grill is in use. Young children should be kept away.**

### DURING USE

- This appliance is not intended to be operated by means of an external timer or separate remote control system.
- **Do not** use this appliance if it is in contact with water. **Never** operate it with wet hands.
- **Take great** care when heating fats and oils as they will ignite if they become too **hot**.
- When you are lighting any burner check that it is lit before you leave the appliance. When turning off a burner, **do not** leave the appliance until the flame has gone out.

- **Always** use oven gloves to remove and place food in the oven. **Ensure** that the vents at the top of the oven are not obstructed to ensure ventilation of the oven cavity.
- **Never** line any part of the appliance with foil.
- **Do not** allow heatproof cooking material, e.g. roasting bags to come into contact with oven elements because they may catch fire.
- **Always** stand back from the appliance when opening the oven door to allow any build up of steam or heat to release.
- **Never leave the appliance unattended when the doors are open.**
- **Do not** place sealed cans or aerosols inside the oven. They may explode if they are heated.
- Ensure that all control knobs are in the OFF position when not in use.
- **For hygiene and safety reasons this appliance should be kept clean at all times. A build up of fats or other foodstuffs could result in a fire, especially in the grill pan.**
- **Do not** stand on the appliance or on the open oven doors.
- **Do not** hang towels, dishcloths or clothes from the appliance or its handles.

### CLEANING AND MAINTENANCE

- **Do not** leave cookware containing foodstuffs, e.g. fat or oil in the appliance in case it is inadvertently switched on.
- **Do not** disconnect the appliance from the gas supply if the supply pipe does not have a bayonet connection as described in the installation section. If this is the case contact the person who installed the appliance.
- Only clean this appliance in accordance with the instructions given in these books.
- **Always** switch off the electric supply before cleaning the appliance.

### AT THE END OF THE APPLIANCE'S LIFE

- When the time comes to dispose of your appliance please contact your local Council Authority. They can arrange to dispose of the appliance in a safe and controlled manner. The number will be in the telephone book.

**Please read this instruction book carefully before use and retain for future reference.**

To help you the following symbol will be found in the text.



Safety Instruction

# CONTENTS

## FOR THE USER

<b>Important Safety Information</b>	2
<b>Preface</b>	4
<b>Introduction</b>	5
Rating Plate	5
General Notes On Using Your Appliance	5
About Condensation and Steam	5
The Cooling Fan for the Controls	5
Control Panel Indicator Neon(s)	5
Cookware	5
Grill and Oven Furniture	6
<b>The Control Panel</b>	7
<b>The Timer</b>	8
To Set the Time of Day	8
To Use the Timer	8
Automatic Control	9
Setting the Controls for Automatic Use	9
<b>The Gas Hob</b>	10
Uses of the Hob	10
To Light the Hob Burners	10
To Turn Off Any Burner	10
Things to Note	10
Hints & Tips	11
<b>The Dual Grill</b>	12
Uses of the Dual Grill	12
Selecting the Dual Grill	12
Things to Note	12
The Grill Pan and Handle	12
Hints and Tips	13
Grilling Chart	13
<b>The Top Oven</b>	14
Uses of the Top Oven	14
Selecting the Top Oven	14
Things to Note	14
To Fit the Top Oven Shelf	14
Hints and Tips	15
<b>The Main Fan Oven</b>	16
Uses of the Main Fan Oven	16
Preheating	16
Cooking Temperatures	16
Batch Baking	16
Selecting the Main Fan Oven	16
Things to Note	16
To Fit the Main Oven Shelves	16
Hints and Tips	17
<b>Oven Cooking Chart</b>	18
<b>Roasting Chart</b>	19

<b>Defrost Feature</b>	20
Uses of Defrost Feature	20
Selecting Defrost	20
Things to Note	20
Hints and Tips	20
<b>Care and Cleaning</b>	21
Cleaning Materials	21
Cleaning the Hob	21
When Replacing Hotplate Burner Parts	21
Cleaning the Outside of the Appliance	22
Cleaning the Grill and Oven Furniture	22
Care of Stayclean Surfaces	22
Hints and Tips	22
Cleaning the Door Glass	23
Cleaning Between the Outer and Inner Door Glass	23
To Remove the Outer Glass	23
To Replace the Outer Glass	23
To Clean the Inner Door Glass Panels	24
<b>Replacing the Oven Light Bulb</b>	24
<b>Something Not Working?</b>	25
<b>Service and Spare Parts</b>	26
<b>Guarantee Conditions</b>	27

## FOR THE INSTALLER

Technical Details	28
For Your Safety	29
Warnings	29
Choice of Electrical Connection	29
Things to Note	29
Safety Requirements / Ventilation	30
Moving Your Appliance	30
For Your Safety	30
Location of Appliance	31
Connecting to the Electricity Supply	32
Connecting to Gas Supply	33
Fitting the Stability Bracket	34
Pressure Testing	35
Checking the Grill	35
Checking the Hotplate	35
To Set the Time of Day	35
Checking the Main Oven	36
Checking the Second Oven	36
General Note	36
Notes	37

## PREFACE

Dear Customer,

Thank you for buying a Zanussi-Electrolux appliance. With our experience in developing and manufacturing the very best in U.K. appliances, you can be assured that you have purchased a hard working, reliable, quality product.

Zanussi-Electrolux appliances comply with British Standard safety and performance requirements. They are covered by a 12 month parts and labour guarantee.

To get the best from your new appliance, we ask that you PLEASE READ THESE INSTRUCTIONS CAREFULLY. Particular attention should be made to cooking times and temperatures, which may differ, from your previous appliance.

It is most important that this instruction book is retained with the appliance for future reference. Should the appliance be sold, or if you move house and leave the appliance, always ensure that the book remains with the appliance. This will enable the new owner to be acquainted with the functioning of the appliance and the relevant warnings.

Please read the whole instruction book before attempting to use the appliance ensuring you follow the recommendations given.

### **WARNING: THIS APPLIANCE MUST BE EARTHED**

#### **RATING PLATE**

This is situated on the front frame of the appliance and can be seen upon opening the door. Alternatively the rating plate may also be found on the back or top of some models (where applicable).

The appliance must be protected by a suitably rated fuse or circuit breaker. The rating of the appliance is given on the rating plate.

**Do not remove the rating plate from the appliance as this may invalidate the guarantee.**

#### **GENERAL NOTES ON USING YOUR APPLIANCE**

We suggest that you run the oven elements for 10 – 15 minutes at 220°C to burn off any residue from their surfaces.

The procedure should be repeated with the grill for approximately 5 – 10 minutes. During this period an odour may be emitted, it is therefore advisable to open a window for ventilation.

#### **ABOUT CONDENSATION AND STEAM**

When food is heated it produces steam similar to a boiling kettle. The oven is vented to allow some of this steam to escape. However, always stand back from the appliance when opening the oven door to allow any build up of steam or heat to release.

If the steam comes into contact with a cool surface on the outside of the appliance, e.g. a trim, it will condense and produce water droplets. This is quite normal and is not caused by a fault on the appliance.

To prevent discolouration, regularly wipe away condensation and also soilage from surfaces.

For your safety wallcoverings at the rear of the appliance should be securely fixed to the wall.

#### **THE COOLING FAN FOR THE CONTROLS**

The cooling fan operates immediately when the grill or top oven is switched on. It may run on after the controls are switched off until the appliance has cooled. If an automatic programme has been set the cooling fan does not switch on until the cooktime begins.

The cooling fan may operate after a time when the fan oven is in use. This will depend on the temperature setting and the length of time the oven has been in use.

#### **CONTROL PANEL INDICATOR NEON(S)**

The indicator neon will operate when the grill (where applicable) or oven(s) is switched on. The indicator neon will glow. It may turn on and off during use to show that the setting is being maintained. If the neon does not operate as the instructions indicate the controls have been incorrectly set. Return all controls to zero and reset following the instructions for the required setting.

#### **COOKWARE**

Baking trays, oven dishes etc., should not be placed directly against the grid covering the fan at the back of the oven.

**Do not** use baking trays larger than 30cm x 35cm (12" x 14") as they will restrict the circulation of heat and may affect performance.

## GRILL AND OVEN FURNITURE

The following items of grill and oven furniture have been supplied with the appliance. If you require replacements of any of the items listed below please contact your local Service Force Centre, quoting the relevant part number.

1 grill pan  
(311409401)

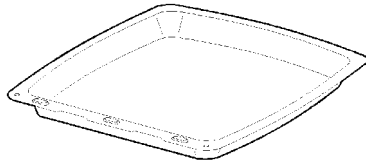

1 grill pan handle  
(311468100)

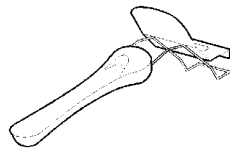

### **Note:**

If you require an additional handle for your grill pan, this can be ordered from your local Service Force Centre by quoting part number 311479800\6.

1 grill pan grid  
(311419801)

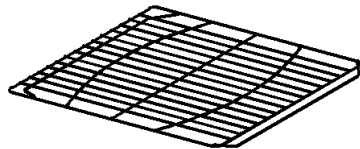

1 cranked shelf  
for grilling and top  
oven cooking only

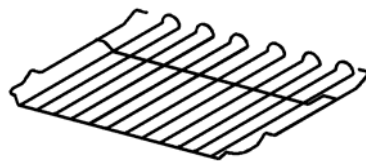

2 straight shelves  
for fan oven cooking

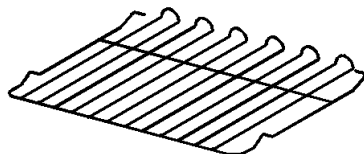

Scuffing of the Stayclean panel/s by the oven furniture pack may occur during transit. These marks will disappear after the oven elements have been burnt off for the first time.

# THE CONTROL PANEL

## THE CONTROL PANEL ZCM8021

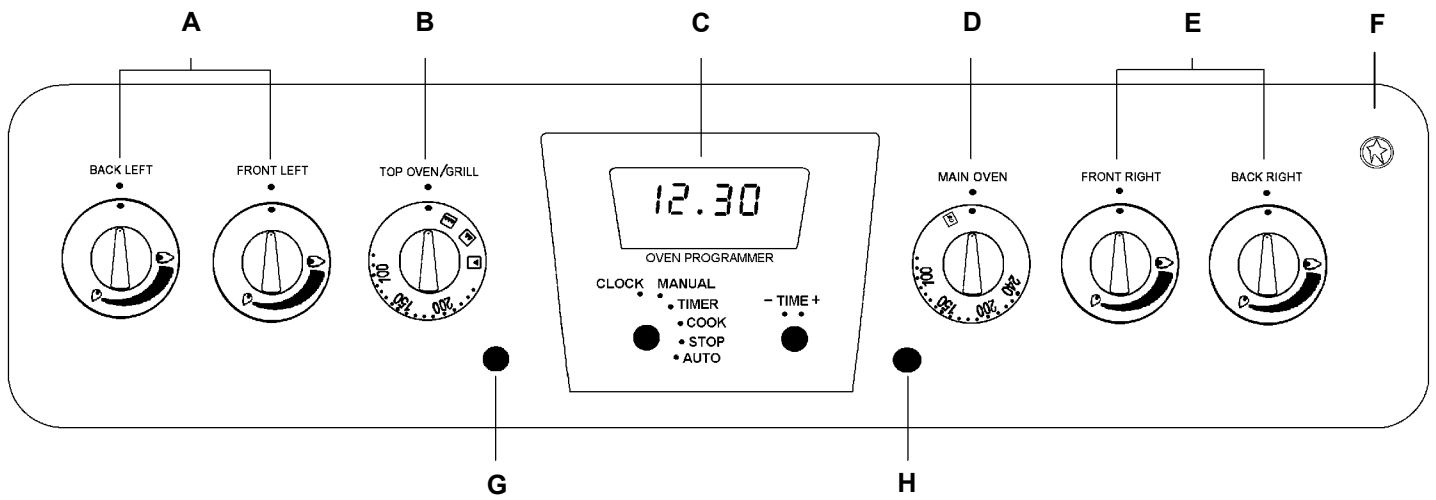

### FEATURES

- A - Hotplate Controls
- B - Top Oven / Grill Temperature Control
- C - Automatic Timer
- D - Main Oven Temperature Control
- E - Hotplate Controls
- F - Ignition Button
- G - Top Oven Indicator Neon
- H - Main Oven Indicator

## THE TIMER

Please note that this is a 24 hour clock, for example 2.00pm is shown as 1400.

In the following pages we explain how to set the controls. Read through them a few times until you are familiar with the procedure.

If the appliance is switched off on the wall, or there is a loss of power, the clock will stop and you will not be able to use the main oven. When you first switch the electricity supply on, the timer display will flash.

### TO SET THE TIME OF DAY

Turn the selector knob to 'Manual' then turn to 'Clock'. Set the correct time by turning and holding the setting knob clockwise. Adjust the time by turning the setting knob in either direction.

Turn the selector knob back to 'Manual'.

### TO USE THE TIMER

Turn the selector knob to 'Timer'. Turn the setting knob clockwise until the display shows the time you want. The bell symbol (🔔) will be showing and this will stay lit up during the time. Our diagram shows the timer set to 5 minutes.

If you change your mind and want to cancel the time you have set, simply turn the setting knob anticlockwise. Then turn the selector to 'Manual'.

When you are using the timer you can make the clock show the time of day by turning the selector knob to 'Manual'. The bell symbol will stay on to remind you that the timer is set. At the end of the timed period an alarm will sound and the bell symbol will go out.

Switch off the alarm by turning the selector knob to 'Clock'. Then turn to 'Manual' and the time of day will show in the display.

#### Note:

You can use the timer when an automatic sequence has been set, as long as you remember the following point.

1. Turn the selector knob to 'Auto' as soon as you have entered the timed period into the display.

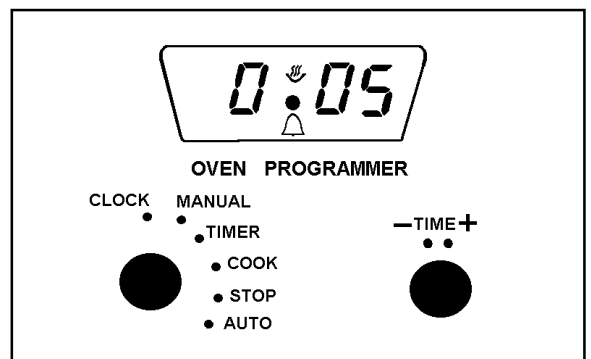
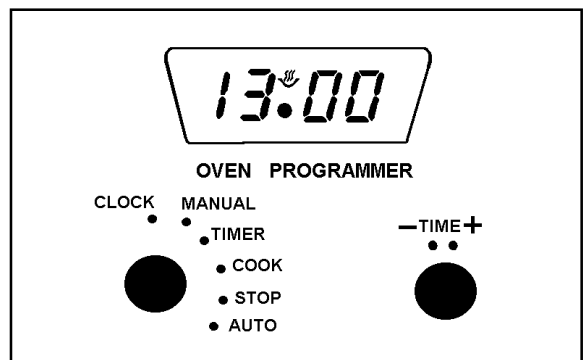
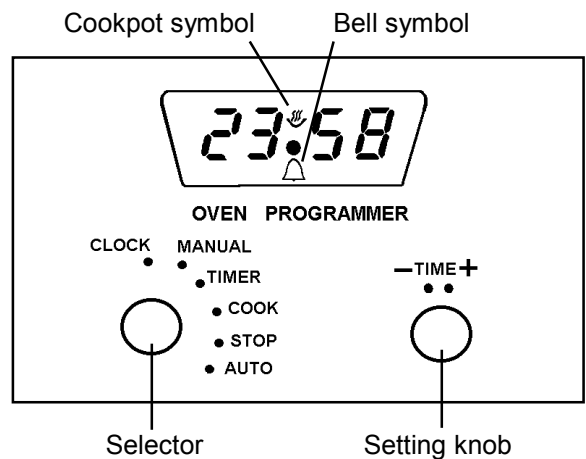



## AUTOMATIC CONTROL

You can only use the automatic control for the main oven. When you use the automatic controls for the first time it's probably best to choose a time when you are at home. That way you can check to make sure you've set everything correctly and you'll feel much more confident when you are away from home in the future.

### SETTING THE CONTROLS FOR AUTOMATIC USE

This is very easy. All you have to do is work through the steps below. The clock will work out the rest for itself.

- |   |   |  |
|---|---|--|
| 1 | Is the electricity supply on?                   |  |
| 2 | Is the clock showing the correct time?          | To adjust turn the selector knob to 'Manual' then to 'Clock'. Turn the setting knob in either direction.   |
| 3 | How long will the food take to cook?            | Turn the selector knob to 'Cook'. Then turn the setting knob until the length of time you want the food to cook shows in the display. The maximum cooking time is 10 hours. 'Auto' will show in the display.   |
| 4 | What time do you want the food to be cooked by? | Turn the selector knob to 'Stop'. Turn the setting knob until the time the oven is to switch off shows in the display. The cookpot (☺) will go out. The 'Stop' time must not be more than 23 hours 59 minutes from the time of day. For example if the time of day is 9.00 am the latest 'Stop' time will be 8.59 am the next day. |
| 5 | Set to automatic.                               | Turn the selector knob to 'Auto'.  |
| 6 | Turn on the oven control.                       | Turn the oven control to the required temperature.   |

The time shown on the right gives an example of setting the automatic controls when the time is 9.00 am, the food is to be cooked for 2½ hours and the food is needed at 6.00 p.m. (1800 hours).

The clock will work out what time the oven will switch itself on and it will turn the oven off at the end. Once the automatic sequence is finished there will be an alarm to remind you that you need to set the oven for manual operation. To do this turn the selector knob to 'Manual'. Turn off the oven control.

If you change your mind and want to cancel a programme that you have set simply turn to 'Clock' and then to 'Manual'.

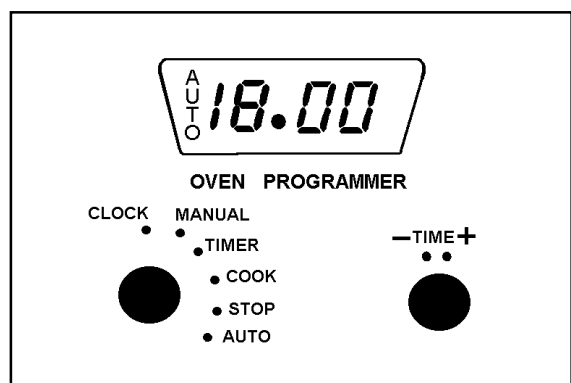
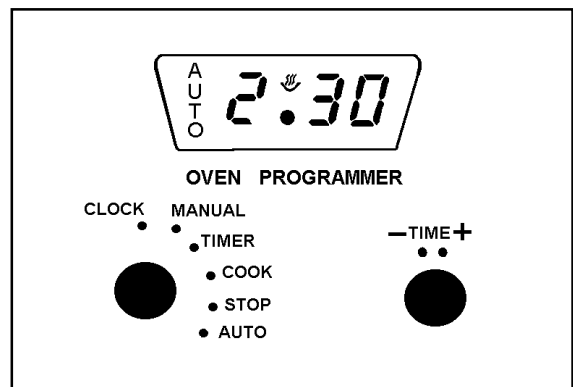
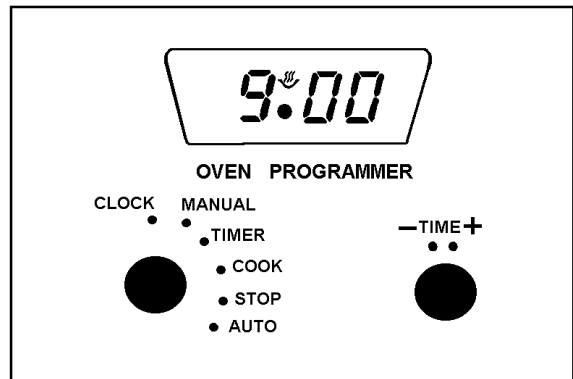

# THE GAS HOB

## SELECTING THE HOB

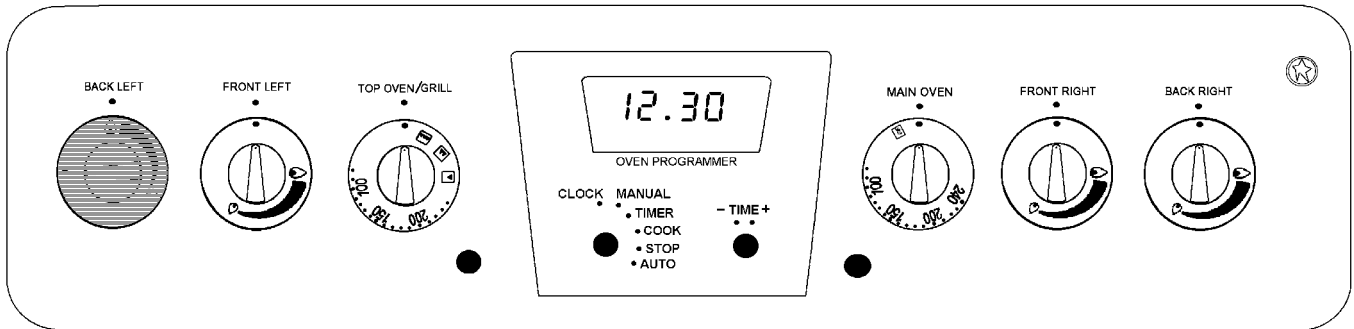

### USES OF THE HOB

The gas hob has three different burner sizes to suit different types of cooking:

To ensure maximum burner efficiency only use pots and pans with flat bases appropriate to the burner size used.

Larger burner (Rapid) - use a large pan for food such as chips.

Medium burners (Normal) - use for everyday cooking.

Small burner (Simmer) - use for simmering foods such as soups and stews.

The largest pan which you should use on any burner is 230mm (9"). The base of the smallest pan should not measure less than 100mm (4").



**Ensure the pan supports are correctly fitted before using the hob.**

### TO LIGHT THE HOB BURNERS

The hob ignition works by means of an electric spark system.

1. Push in and turn the control knob to the left to the highest setting. This is shown by a large flame symbol. Press the ignition button immediately.
2. When the burner has lit release the control and adjust the setting as required.



**Warning: If the ignition button is not pressed immediately a build up of gas may cause the flame to spread.**

### TO TURN OFF ANY BURNER

1. Turn the control knob to the off position. This is shown by a large dot.



**When lighting any burner, ensure that it is lit before you leave the appliance.**

**When turning off a burner, ensure the flame has gone out before leaving the appliance.**

In the event of the burner flames being accidentally extinguished, turn off the burner control and do not attempt to re-ignite the burner for at least 1 min.

### THINGS TO NOTE

If you are having any difficulty lighting a hob burner turn all the hob controls off and make sure the burner parts have been replaced correctly.

### HEAT CONTROL

The hotplate control knobs turn anticlockwise from 'OFF' to 'HIGH' and then to 'LOW'. You can adjust the heat by turning the control between the highest and lowest settings. These are shown as a large and a small flame symbol.

## HINTS AND TIPS

- Keep flames under the base of pans. If the flames lick round the sides of the pan you are wasting gas.
- **Do not** overfill pans or they will boil over.
- **Do not** use pans with very heavy handles which cause the pan to tip.
- Use pans with flat bases. They are more stable than pans which are warped.



**Place pans on the centre of the burners.**  
**Position pans so the handles cannot be accidentally knocked or overhang the appliance.**  
**Lift pans on and off the pan supports.**  
**Do not slide them across the hob.**

---

- **Do not** leave accidental spillage on the hob or removable parts. The spillage should be wiped up and the parts washed and carefully dried as soon as the hob, pan supports and burner parts are cool enough to touch.
- Cover pans with a lid whenever possible. Food will heat up more quickly and there will be less steam in the kitchen.
- A flat based Wok will stand stable on the pan supports. If you use a round Wok with a collar support, the collar must be the open wirework type otherwise the performance of the burner will be affected.



**Take care to avoid burns and scalds when reaching across the hotplate.**

---



**Take extra care when deep fat frying, do not cover the pan with a lid. Do not leave a pan unattended. If the pan catches fire, leave it where it is and turn off all controls. Place a damp cloth or a fitting lid over the pan to smother the flames. Never put water on the fire. Leave to cool for 30 minutes.**

---

# THE DUAL GRILL

## USES OF THE DUAL GRILL

**CAUTION - ACCESSIBLE PARTS MAY BECOME HOT WHEN THE GRILL IS IN USE. CHILDREN SHOULD BE KEPT AWAY.**

The Dual Grill on this appliance has been designed to heat up more quickly than conventional grill elements. It provides quick, direct heat and no preheating is necessary. It has a dual circuit facility which means that the full area of the grill can be used, or for economy purposes the centre section only can be used when cooking smaller quantities of food.

## SELECTING THE GRILL

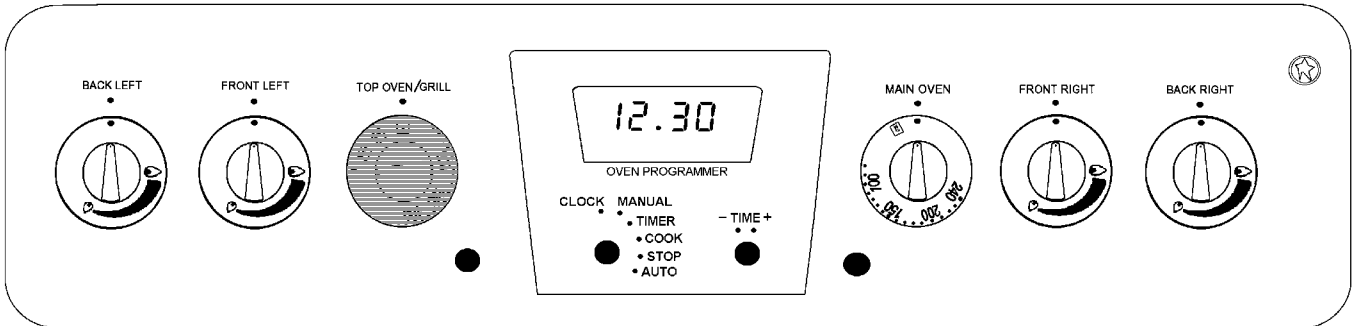

- To operate the grill turn the top oven/grill control clockwise to the full power setting ( ▼▼▼ ), then turn down as necessary.

The grill settings are as follows:-

- ( ▼ ) Full grill area at ¼ power.
- ( ▼▼ ) Centre grill area at full power.
- ( ▼▼▼ ) Full grill area at full power.

## THINGS TO NOTE

THE GRILL DOOR MUST BE LEFT OPEN DURING GRILLING.

THE COOLING FAN WILL OPERATE IN CONJUNCTION WITH THE GRILL.

DO NOT LEAVE APPLIANCE UNATTENDED WHEN GRILL IS IN USE.

ALWAYS USE THE GRILL CONTROL TO TURN OFF THE GRILL

The top oven cannot be operated when the grill is in use.

Some smoke from fat splashes may be evident as the grill cleans itself.

## THE GRILL PAN AND HANDLE

The grill pan is supplied with a removable handle.

To attach the handle, place the wirework under the cut out in the pan so that the metal plate hooks over the top of the grill pan.

Slide the handle to the left and over the central bump on the grill pan.

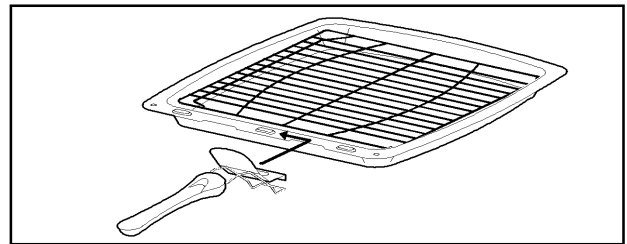

**Ensure the handle is correctly located. It is not necessary to remove the grill pan handle during grilling.**

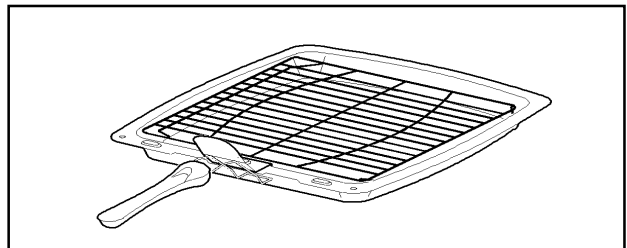

To remove the handle, slide the handle to the right and lift the handle away from the cut out on the grill pan.

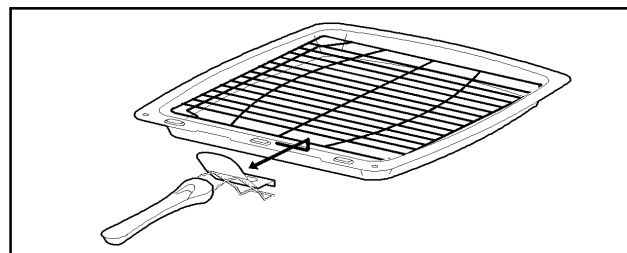

Place the grill pan on the shelf so that the pan is positioned centrally beneath the grill.

## HINTS AND TIPS

- In order to become acquainted with the performance of the Dual Grill it is advisable to check food regularly when grilling.
- Food should be thoroughly dried before grilling to minimise splashing. Brush lean meats and fish lightly with a little oil or melted butter to keep them moist during cooking.

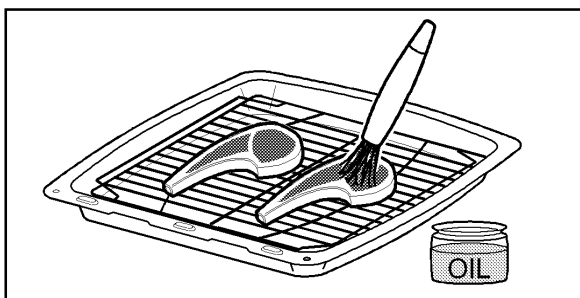

- Adjust the height of the grilling grid and grill pan runner position to allow for different thicknesses of foods.
- Accompaniments such as tomatoes and mushrooms may be placed underneath the grid when grilling meats.

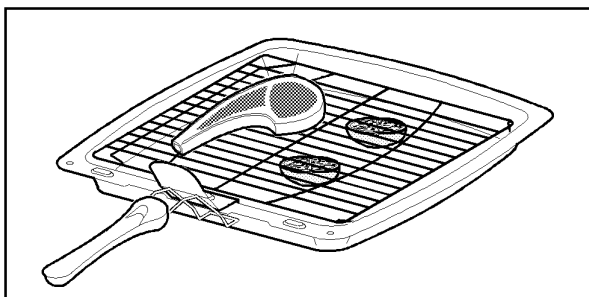

- When toasting bread use the shelf in position 1 with the grid in the high position.
- Preheat the grill on a full setting for a few minutes before cooking. Adjust the heat setting and runner position as necessary during cooking.
- The food should be turned over during cooking as required.
- When using the centre section of the dual grill, ensure food is positioned centrally on the grill pan grid in the grill pan.

### NOTE:

If you require an additional handle for your grill pan, this can be ordered from your local Service Force Centre by quoting part number 3114798006.

## GRILLING CHART

FOOD	SHELF	GRILL TIME (mins in total)
Bacon Rashers	Adjust	5 - 6
Beefburgers	grill setting	10 - 15
Chicken Joints	shelf	30 - 40
Chops – Lamb Pork	position and	15 - 20 20 - 30
Fish – Whole Trout/Mackerel	grill	15 - 25
Fillets – Plaice/Cod	pan	10 - 15
Kebabs	grid	20 - 30
Kidneys – Lamb/Pig	to	8 - 12
Liver – Lamb/Pig	suit	10 - 20
Sausages	different	20 - 30
Steaks – Rare Medium Well Done	thicknesses of	6 - 12 12 - 16 14 - 20
Toasted Sandwiches	food	3 - 4

The times quoted above are given as a guide and should be adjusted to suit personal taste.

## THE TOP OVEN

### USES OF THE TOP OVEN

The top oven is the smaller of the two ovens. It is heated by elements in the top and bottom of the oven. It is designed for cooking smaller quantities of food. It gives especially good results if used to cook fruit cakes, sweet or savoury flans or quiche.

The top oven is also ideal for use as a warming compartment to warm dishes and keep food hot. Use the lowest setting on the top oven temperature control.

### SELECTING THE TOP OVEN

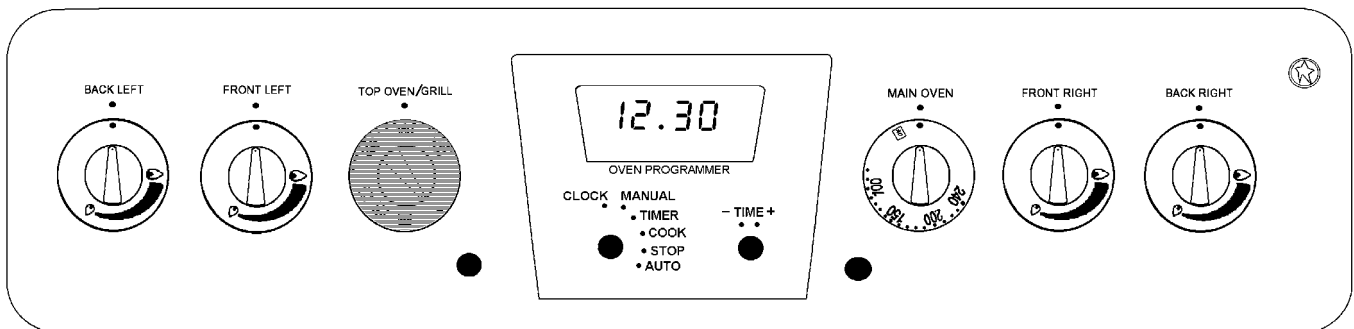

- To operate the top oven turn the temperature control to the required setting. Our diagram shows the oven set to 150°C. Close the oven door.

### THINGS TO NOTE

1. The grill cannot be operated if the top oven is in use.
2. The indicator neon will glow. It may turn ON and OFF during use to show that the setting is being maintained.
3. The cooling fan will operate.
4. The interior oven light will come ON when the top oven control is turned.
5. Always place plates on the oven shelf to warm. Never place dishes directly on the top oven base as it becomes very hot and damage may occur.

### TO FIT THE TOP OVEN SHELF

The shelf should be fitted with the straight rods uppermost on the frame and the forms towards the back of the oven. If not fitted correctly the anti-tilt and safety stop mechanism will be affected.

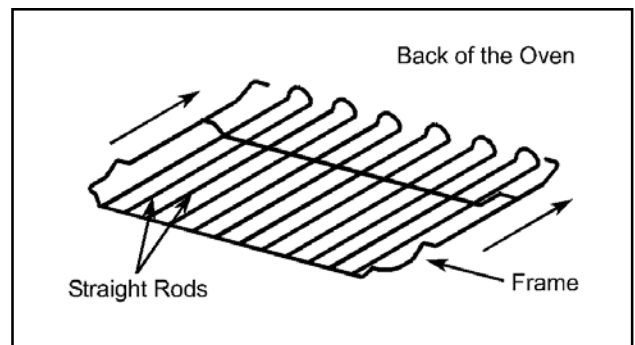

## HINTS AND TIPS

- Most cooking should be carried out using an oven shelf positioned in one of the shelf runners.

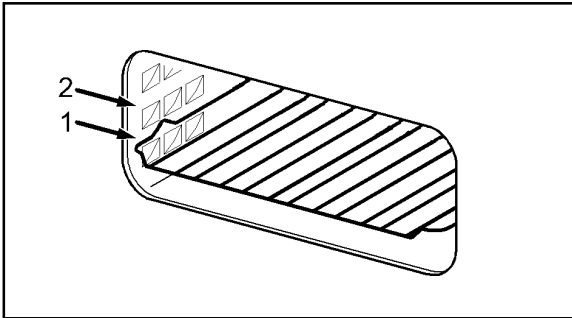

- Larger roasts and casseroles should normally be cooked in the main fan oven. However, they may be cooked on a straight shelf placed on the base of the top oven provided there is sufficient room for air circulation around the food.
- Stand dishes on a suitably sized baking tray on the shelf to prevent spillage onto the oven base and to help reduce cleaning.

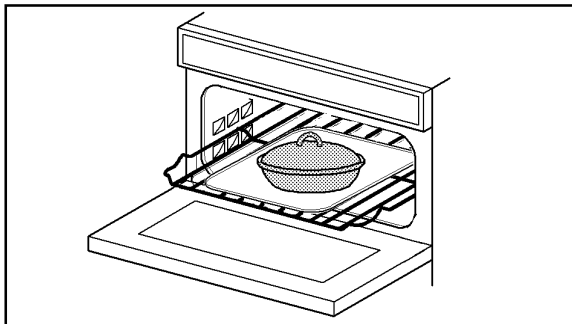

- There should always be at least 2.5cm (1") between the top of the food and the element. This gives best cooking results and allows room for rise in yeast mixtures, Yorkshire puddings etc.

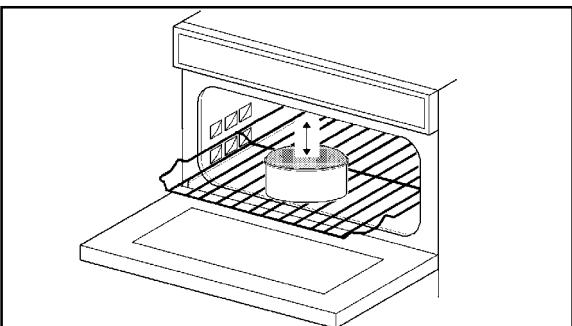

- When cooking cakes, pastry, scones, bread etc., place the tins or baking trays centrally on the shelf directly below the element.

- **DO NOT** place dishes or baking trays directly onto the oven base as it becomes very hot and damage may occur.

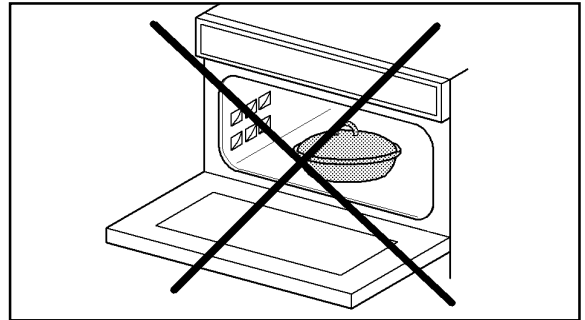

- The material and finish of the baking trays and dishes will affect the degree of base browning of the food. Enamelware, dark, heavy or non-stick utensils increase base browning. Shiny aluminium or polished steel trays reflect the heat away and give less base browning.
- **DO NOT** use the grill pan as a baking tray as this will increase base browning of the food.
- Because of the smaller cooking space, lower temperatures and shorter cooking times are sometimes required.
- For economy leave the door open for the shortest possible time, particularly when placing food into a pre-heated oven.

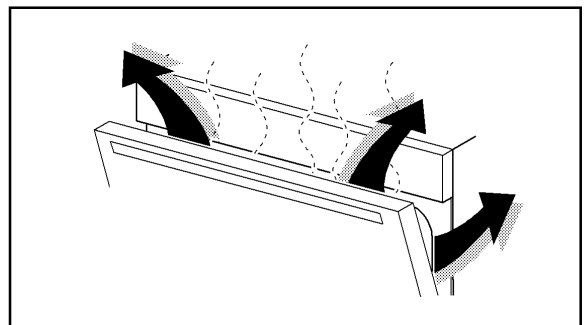

## THE MAIN FAN OVEN

### USES OF THE MAIN FAN OVEN

The oven is heated by an element around the fan situated behind the back panel. The fan draws air from the oven and the element heats the air which circulates in the oven via the vents in the back panel. The advantages of fan oven cooking are:

#### PREHEATING

The fan oven quickly reaches its temperature, so it is not usually necessary to preheat the oven. Without preheating however, you may find you need to add an extra 5 – 10 minutes on the recommended cooking times. For recipes needing high temperatures, e.g. bread, pastries, scones, soufflés etc., best results are achieved if the oven is preheated first. For best results when cooking frozen or cooked chilled ready meals always preheat the oven first.

#### COOKING TEMPERATURES

Fan oven cooking generally requires lower temperatures than conventional cooking. Follow the temperature recommended in the oven cooking chart. As a guide reduce temperatures by about 20°C - 25°C for your own recipes, using a conventional oven.

#### BATCH BAKING

The fan oven cooks evenly on all shelf levels, especially useful when batch baking.

### SELECTING THE MAIN FAN OVEN

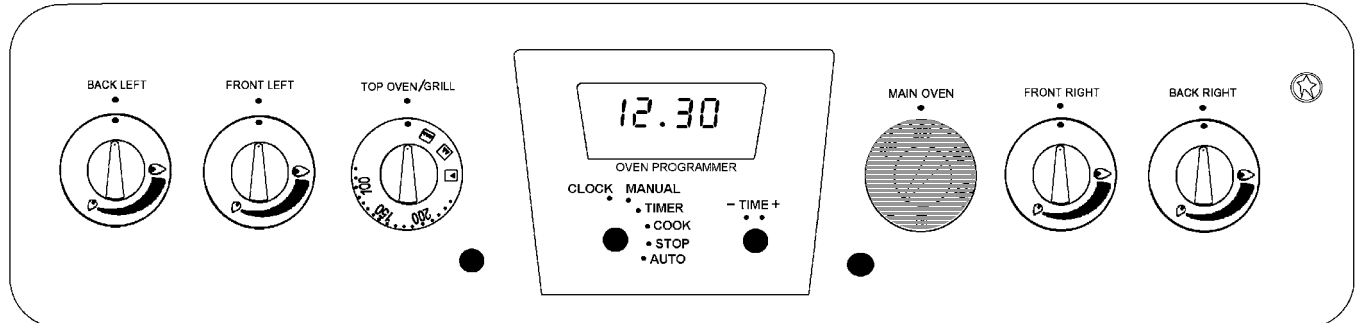

- Turn the main fan oven temperature control to the required setting.

#### THINGS TO NOTE

1. The indicator neon will glow. It may turn ON and OFF during use to show that the setting is being maintained.
2. The interior oven light will come ON when the main oven control is turned.

#### TO FIT THE MAIN OVEN SHELVES

The shelves should be fitted with the straight rods uppermost on the frame and the forms towards the back of the oven. If not fitted correctly the anti-tilt and safety stop mechanism will be affected.

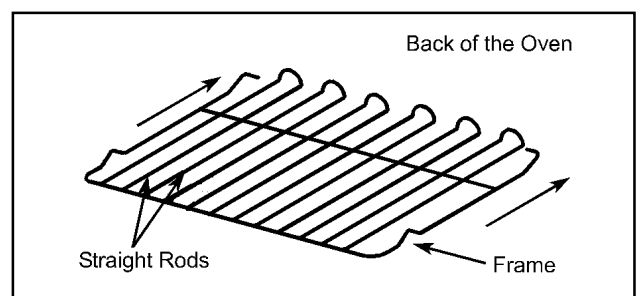



## HINTS AND TIPS

- Arrange the shelves in the required positions before switching the oven ON. Shelf positions are numbered from the bottom upwards.

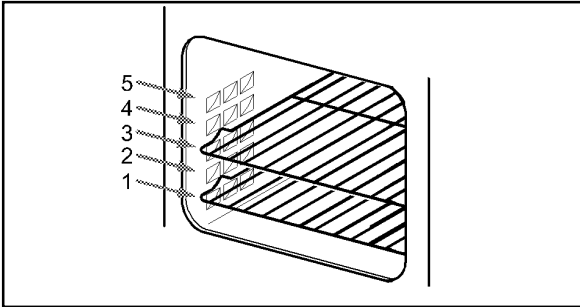

- When cooking more than one dish in the fan oven, place dishes centrally on different shelves rather than cluster several dishes on one shelf, this will allow the heat to circulate freely for the best cooking results.
- When batch baking one type of food e.g. Victoria sandwich cakes, those of similar size will be cooked in the same time.

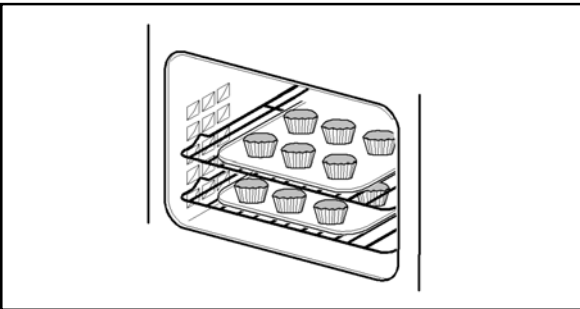

- It is recommended that when baking larger quantities, the shelf positions should be evenly spaced to suit the load being cooked. A slight increase in cooking time may be necessary.
- **DO NOT** place baking trays directly on the oven base as it interferes with the oven air circulation and can lead to base burning; use the lower shelf position.

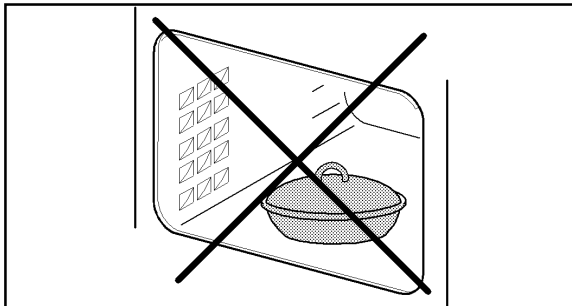

- The use of excessively high temperatures can cause uneven browning. It may be necessary to reduce temperatures slightly. Refer to the recommendations given in the oven cooking chart.

## OVEN COOKING CHART

The oven temperatures are intended as a guide only. It may be necessary to increase or decrease the temperatures by 10°C to suit individual preferences and requirements.

FOOD	FAN OVEN		TOP OVEN		
	SHELF POSITION	COOKING TEMP °C	SHELF POSITION	COOKING TEMP °C	APPROX COOK TIME (m)
Biscuits		180 - 190	1	170 - 190	10 - 20
Bread		200 - 220	1*	200 - 220	25 - 30
Bread rolls/buns	Shelf	200 - 220	1	200 - 220	15 - 20
Cakes:					
Small & Queen		160 - 170	1	180 - 190	18 - 25
Sponges		160 - 170	1	160 - 170	18 - 20
Victoria Sandwich	positions	160 - 170	1	160 - 170	18 - 25
Madeira		140 - 150	1	140 - 150	1¼ - 1½h
Rich Fruit		130 - 140	1	140 - 150	2¼ - 2½h
Christmas	are not	130 - 140	1	130 - 140	3 - 4½h
					depends on size
Gingerbread		140 - 150	1	140 - 150	1¼ - 1½h
Meringues	critical	80 - 100	1	90 - 100	2½ - 3h
Flapjack		170 - 180	1	170 - 180	25 - 30
Shortbread		130 - 140	1	140 - 150	45 - 65
Casseroles:					
Beef/Lamb	but ensure	140 - 160	1*	140 - 160	2½ - 3h
Chicken		180 - 190	1*	180 - 190	1¼ - 1½h
Convenience Foods		Follow manufacturer's instructions			
Fish	that oven	170 - 190	1	170 - 190	20 - 30
Fish Pie (Potato Topped)		190 - 200	1*	190 - 200	20 - 25
Fruit Pies, Crumbles		190 - 200	1	190 - 200	40 - 50
Milk Puddings	shelves	130 - 140	1	140 - 150	1½ - 2h
Pasta Lasagne etc.		190 - 200	1	170 - 180	40 - 45
Pastry:					
Choux	are	190 - 200	1	180 - 190	30 - 35
Eclairs, Profiteroles		170 - 180	1	170 - 180	20 - 30
Flaky/Puff Pies		210 - 220	1*	210 - 220	25 - 40
Shortcrust					
Mince Pies	evenly	190 - 200	1	190 - 200	15 - 20
Meat Pies		190 - 210	1*	190 - 210	25 - 35
Quiche, Tarts, Flans		180 - 210	1	180 - 200	25 - 45
	spaced				
Roasting Meat, Poultry		160 - 180	1*	160 - 180	see roasting chart
Scones	when more	210 - 220	1	220 - 230	8 - 12
Shepherd's Pie		190 - 200	1*	190 - 200	30 - 40
Soufflés		170 - 180	1	170 - 180	20 - 30
Vegetables:					
Baked Jacket Potatoes	than one is	180 - 190	1	180 - 190	1 - 1½h
Roast Potatoes		180 - 190	1	180 - 190	1 - 1½h
Yorkshire Puddings:					
Large	used	210 - 220	1	200 - 210	25 - 40
Individual		200 - 210	1	200 - 210	15 - 25

\* = Straight shelf on the oven base.

**Note:** Shelf positions are counted from the bottom of the oven.

## ROASTING CHART

ROASTING CHART		
INTERNAL TEMPERATURES – Rare : 50-60°C; Medium : 60-70°C; Well done : 70-80°C		
MEAT	TOP/FAN OVEN	COOKING TIME
Beef	160-180°C	20-35 minutes per ½kg (1lb) and 20-35 minutes over
Beef, boned	160-180°C	25-35 minutes per ½kg (1lb) and 25-35 minutes over
Mutton and Lamb	160-180°C	25-35 minutes per ½kg (1lb) and 25-35 minutes over
Pork and Veal	160-180°C	30-40 minutes per ½kg (1lb) and 30-40 minutes over
Ham	160-180°C	30-40 minutes per ½kg (1lb) and 30-40 minutes over
Chicken	160-180°C	15-20 minutes per ½kg (1lb) and 20 minutes over
Turkey and Goose	160-180°C	15-20 minutes per ½kg (1lb) up to 3½kg (7lb) then 10 minutes per ½kg (1lb) over 3½kg (7lb)
Duck	160-180°C	25-35 minutes per ½kg (1lb) and 25-30 minutes over
Pheasant	160-180°C	35-40 minutes per ½kg (1lb) and 35-40 minutes over
Rabbit	160-180°C	20 minutes per ½kg (1lb) and 20 minutes over
Potatoes with meat	160-180°C	according to size
Potatoes without meat	180-190°C	according to size

The roasting temperatures and times given in the chart should be adequate for most joints, but slight adjustments may be required to allow for personal requirements and the shape and texture of the meat. However, lower temperatures and longer cooking times are recommended for less tender cuts or larger joints.

Wrap joints in foil if preferred, for extra browning uncover for the last 20 – 30 min. cooking time.

## DEFROST FEATURE

### USES OF DEFROST FEATURE

This main oven function defrosts most foods faster than more conventional methods. It is particularly suitable for delicate frozen foods which are to be served cold e.g. cream filled gateaux, cakes covered with icings or frostings, cheesecakes, biscuits, scones, etc.

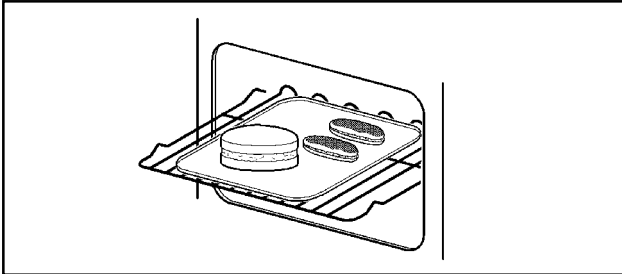

It is preferable to thaw fish, meat and poultry slowly in the fridge. However, this process can be accelerated by using the defrost function.

### SELECTING DEFROST

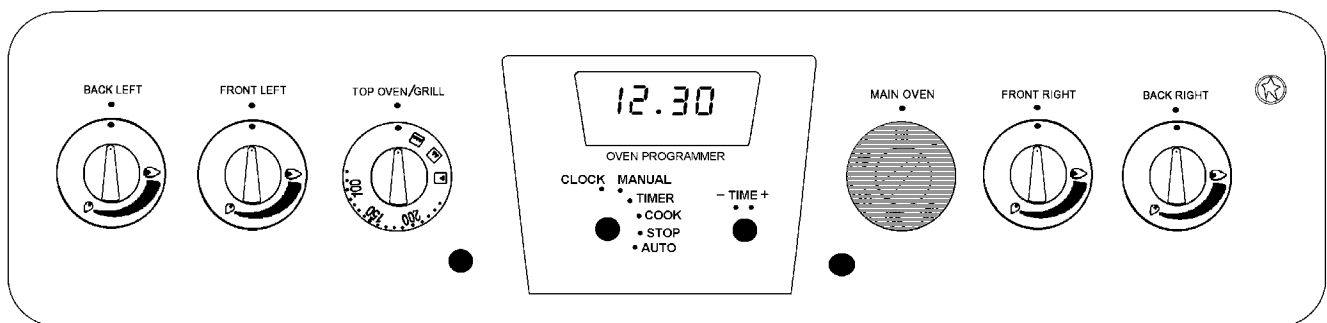

- Turn the main oven temperature control to the defrost setting. 
- When defrost is selected, the oven indicator neon may come ON. It will stay ON until the oven reaches room temperature and then go OFF.
- It may turn ON and OFF periodically during defrosting to maintain a steady room temperature, inside the oven.

### THINGS TO NOTE

Care must always be taken when handling foods in the home. Always follow the basic rules of food hygiene to prevent bacterial and microbial growth and cross contamination when defrosting, preparing, cooking, cooling and freezing foods.

Small or thin fish fillets, frozen peeled prawns, cubed or minced meat, liver, thin chops, steaks etc., can be thawed in 1 – 2 hours.

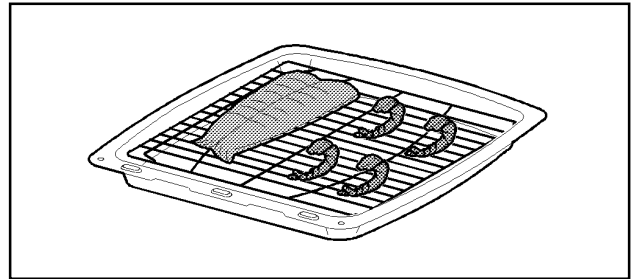

A 1kg/2¼lb oven ready chicken will be thawed in approximately 5 hours. Remove the giblets as soon as possible during the thawing process.

Joints of meat up to 2kg/4½lb in weight can be thawed using the defrost function.

**ALL JOINTS OF MEAT AND POULTRY MUST BE THAWED THOROUGHLY BEFORE COOKING.**

**ALWAYS COOK THOROUGHLY IMMEDIATELY AFTER THAWING.**

### HINTS AND TIPS

- Place the frozen food in a single layer where possible and turn it over half way through the defrosting process.

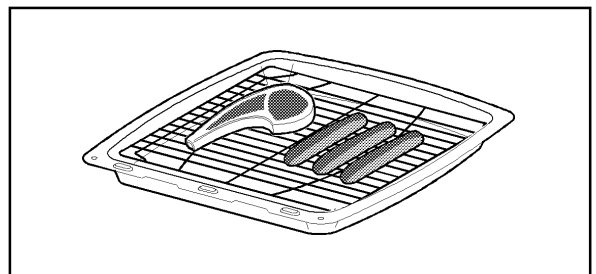

- The actual speed of defrosting is influenced by room temperature. On warm days defrosting will be faster than on cooler days.
- **DO NOT** leave food at room temperature once it is defrosted. Cook raw food immediately or store cooked food in the fridge, once it has cooled

## CARE AND CLEANING

**BEFORE CLEANING THE APPLIANCE, ALWAYS ALLOW THE COOLING FAN TO COOL THE APPLIANCE DOWN BEFORE SWITCHING OFF THE ELECTRICITY SUPPLY.**

### CLEANING MATERIALS

Before using any cleaning materials on your appliance, check that they are suitable and that their use is recommended by the manufacturer.

Cleaners that contain bleach should NOT be used as they may dull the surface finishes. Harsh abrasives must also be avoided to prevent damaging the stainless steel or painted finishes. See 'Cleaning the Outside of the Appliance'.

### CLEANING THE HOB

#### The hotplate

Clean the hotplate top using a mild abrasive such as 'Cif'. Take care not to damage the spark electrodes. If the spark electrodes are damaged the burners will not light.

You can remove the pan supports, burner caps and burner crowns to clean them. Again take care not to damage the spark electrodes.

If any food spills during cooking you can place the pan on another burner to finish cooking. Then you can remove the dirty parts and clean them before the spill 'burns on'.

Clean the burner crowns by soaking them in very hot soapy water. You can remove any stubborn stains by scouring with a soap filled pad such as 'Brillo'. If you look after the burner crowns in this way they will stay reasonably clean. However the surface will dull with time.

Aluminium based saucepans can leave shiny metal marks on the pan supports. Clean the pan supports regularly to remove the marks using a mild abrasive like 'Cif' with a soft scourer. For more stubborn marks you can use a soap-filled pad such as 'Brillo'.

After cleaning the appliance parts, dry them thoroughly before you put them back.

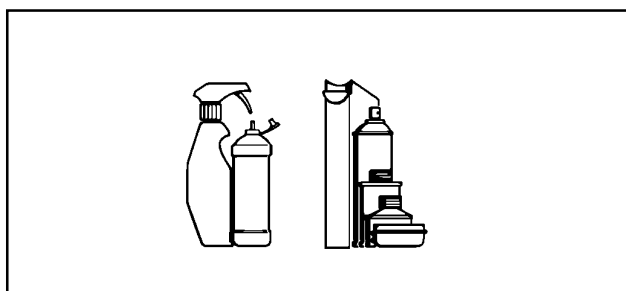

### WHEN REPLACING HOTPLATE BURNER PARTS

1. Crown to body  
(Do not try to force the crown on to the body). Make sure that the hole in the crown is over the electrode. Check that the two longer location pegs sit in the slots in the body. When the crown is in this position let it fall freely on to the body. Check that the crown can be moved slightly from side to side.
2. Cap to crown  
Place cap centrally on the top of crown (enamel side up). Move sideways and front to back to check the cap is properly fitted.
3. Check for ignition  
If a burner will not light then you need to check the crown and cap positions.

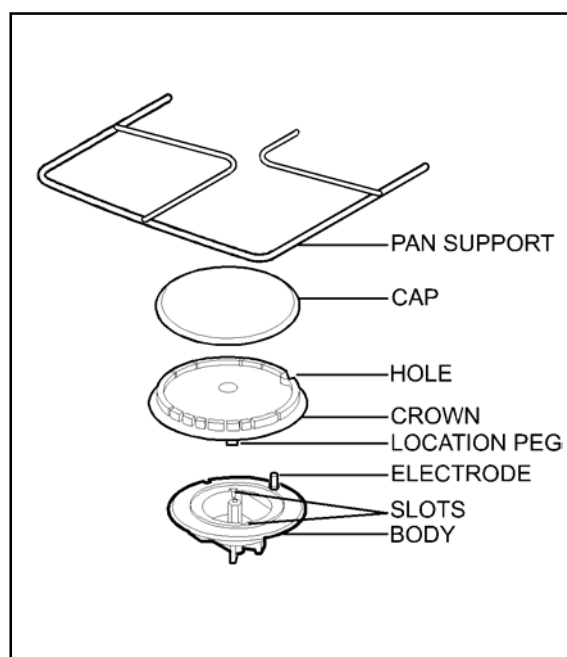

## CLEANING THE OUTSIDE OF THE APPLIANCE

**DO NOT** use abrasive cleaning materials e.g. Hob Brite, Brillo pads or scourers on painted or printed finishes as damage may occur. Regularly wipe over the control panel, oven doors and appliance sides using a soft cloth and hot soapy water. To prevent streaking on stainless steel models finish with a soft cloth.

**Any spillage on the stainless steel finish must be wiped off immediately.**

Stainless Steel cream cleaners are abrasive and should be avoided as they may dull the surface finish.

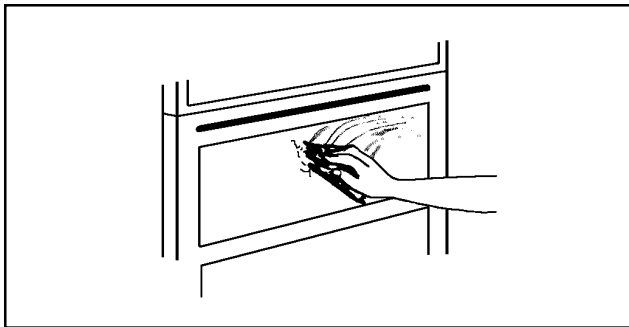

**DO NOT ATTEMPT TO REMOVE ANY OF THE CONTROL KNOBS FROM THE APPLIANCE AS THIS MAY CAUSE DAMAGE AND IS A SAFETY HAZARD.**

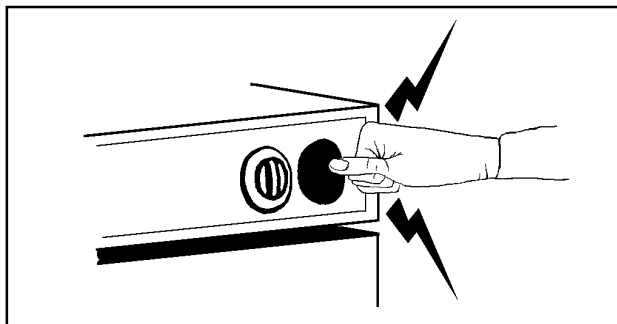

## CLEANING THE CONTROL KNOBS AND HANDLES

It is strongly recommended that only hot soapy water is used for cleaning the control knobs and door handles. **ANY OTHER CLEANING MATERIALS WILL DULL THE SURFACE FINISH.**

## CLEANING THE GRILL AND OVEN FURNITURE

All removable parts, except the grill pan handle can be washed in the dishwasher.

The grill pan, grill pan grid and oven shelves may be cleaned using a soap impregnated steel wool pad. Soaking first in hot soapy water will make cleaning easier.

## CLEANING INSIDE THE GRILL/TOP OVEN AND MAIN OVEN COMPARTMENTS

The top, sides and back of the grill/top oven and main oven compartments are coated with a special Stayclean coating.

The Stayclean surfaces should not be cleaned manually. See below 'Care of Stayclean Surfaces'.

The vitreous enamel in the grill/top oven base and on the main oven base can be cleaned using normal oven cleaners with care. Ensure that the manufacturers instructions are followed and that all parts are well rinsed afterwards.

**Aerosol cleaners must not be used on the Stayclean surfaces and must not come into contact with the elements or the door seal as this may cause damage.**

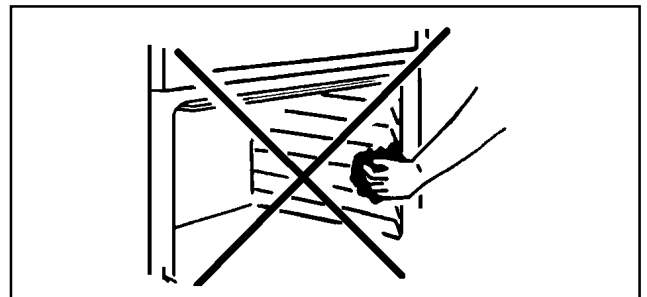

## CARE OF STAYCLEAN SURFACES

Stayclean surfaces destroy splashes of food and fats when the oven temperature is raised to around 220°C.

It is a good idea to run the oven for an hour or two per week to ensure continued good performance from the Stayclean finish.

## HINTS AND TIPS

- Manual cleaning of the Stayclean surfaces IS NOT recommended. Damage will occur if abrasives or aerosol sprays of any kind are used.
- Slight discolouration and polishing of the Stayclean surfaces may occur in time. This **DOES NOT** affect the Stayclean properties in any way.
- A good time to allow the oven to run on is after the weekly roast. After removing the roast, turn the oven up to 220°C and allow to run for an hour or so. It is important NOT to allow a build-up of soilage as this can prevent the Stayclean surfaces from working.
- Follow the recommendations to keep oven soilage to a minimum.

- Cook at the recommended temperatures. Higher temperatures during roasting will increase soilage. Try cooking at lower temperatures for an increased length of time, you will save energy and often the joint is more tender.
- Use minimal, if any, extra oil or fat when roasting meat, potatoes only require brushing with fat before cooking. Extra fat in the oven during roasting will increase splashing and soilage.
- It is not necessary to add water to a meat tin when roasting. The water and the fat juices from the joint create excessive splattering during cooking even at normal temperatures as well as causing condensation.
- Covering joints during cooking will also prevent splashing onto the interior surfaces. Removing the covering for the last 20-30 minutes will allow extra browning if required. Some large joints and turkeys especially benefit by this method of cooking, allowing the joint to cook through before the outside is over-browned.

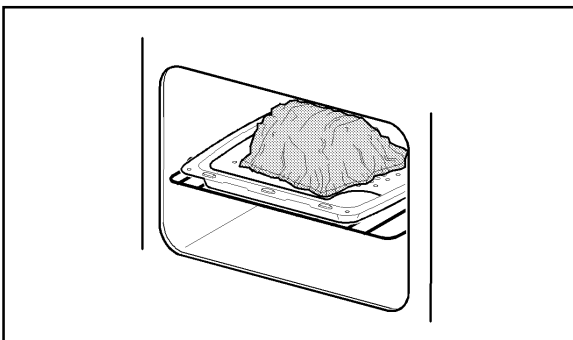

## CLEANING THE DOOR GLASS



To prevent damaging or weakening the door glass panels avoid the use of the following:

- Household detergents and bleaches
- Impregnated pads unsuitable for non-stick saucepans
- Brillo/Ajax pads or steel wool pads
- Chemical oven pads or aerosols
- Rust removers
- Bath/Sink stain removers

## CLEANING BETWEEN THE OUTER AND INNER DOOR GLASS

The outer door glass is removable for cleaning.

### TO REMOVE THE OUTER GLASS

1. Open the oven door slightly to gain access to the two cross head screws on the top of the oven door.
2. Loosen the two screws using a Pozidrive screwdriver.

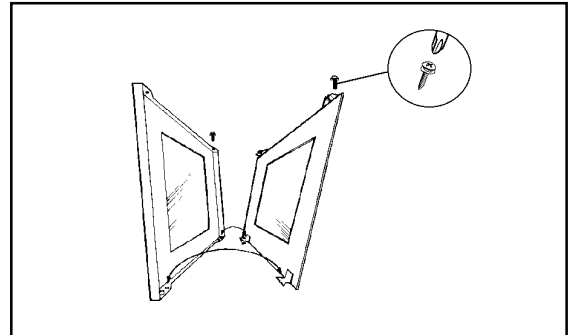

3. Hold the door glass securely in place with one hand before removing the screws completely with the other hand.
4. Using both hands, gently tilt the top of the door glass towards you, lift slightly to disengage the locators from the two bottom brackets.
5. Clean the outer and inner glass using hot soapy water or Hob Brite cleaner may be used with care. **DO NOT** use Hob Brite on the Stainless Steel or painted finishes. **DO NOT** try to clean the foil which is inside the door. The foil is there to help keep the door cool, if it is damaged it will not work. Ensure that all parts are well rinsed and thoroughly dried before attempting to replace the outer door panel.

### TO REPLACE THE OUTER GLASS

1. Holding the oven glass with both hands, gently place the locators into the holes of the brackets at the bottom of the oven door.
2. Push the top of the oven glass towards the oven door, ensuring the screw location holes line up.
3. Hold the panel in place with one hand and insert the cross head screws into the location holes with the other hand. Give the screws one turn to ensure the glass is secure.
4. Tighten the screws positively with a Pozidrive screwdriver before closing the oven door.

**Do not attempt to use the oven without the glass being in place.**

---

**⚠** If the door glass panel becomes chipped or has deep scratches the glass will be weakened and must be replaced to prevent the possibility of the panel shattering. Please contact your local Service Force Centre who will be pleased to advise further.

---

## **TO CLEAN THE INNER GLASS DOOR PANELS**

Clean the inner glass door panels using a soft cloth and hot water to which a little washing up liquid has been added. If the inner panel is heavily soiled, Hob Brite may be used. **Do not** use abrasive cleaning materials on the door glass. Ensure that all parts are well rinsed and thoroughly dried before attempting to replace the glass.

## **REPLACING THE OVEN LIGHT BULB**

The type of bulb required is a 300°C 25 watt small Edison Screw. Part number 572 491 5431-00/1 (Available through your local Service Force Centres).

**CAUTION:** DISCONNECT THE APPLIANCE FROM THE ELECTRICITY SUPPLY BEFORE REPLACING THE BULB.

Open the door and remove the shelves to enable easy access to the oven light assembly. Insert a flat blade screwdriver between the oven side and glass which covers the bulb.

Support the glass with your hand and prise out sufficiently to release the glass cover. Unscrew the bulb in an anticlockwise direction until it is possible to remove the bulb with ease.

Fit the new bulb by turning in a clockwise direction until it is secure. Ensuring the indent to the flange is pointing to the rear of the oven, replace the glass by pushing it firmly into the hole to cover the bulb assembly.

Replace the shelves. Restore the electricity supply and adjust the time of day and clock as necessary.

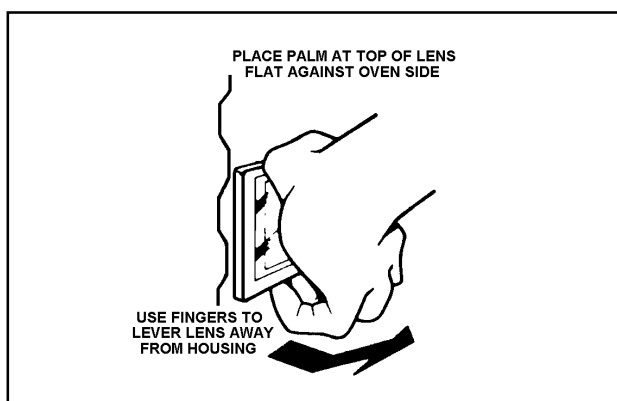



## SOMETHING NOT WORKING?

Before calling an Engineer please carry out the following checks, you may be able to solve the problem without the expense of an Engineer.

If our Service Engineer finds that the problem is listed below you will be charged for the call whether or not the appliance is under guarantee.

### **The appliance does not work at all:**

- \* Check that the appliance has been wired in and is switched on at the wall.
- \* Check that the main appliance fuse is working.
- \* Check that the timer is set to manual.

If you have checked the above:

- \* Switch OFF appliance at the wall and allow the appliance to cool for a couple of hours. Switch ON again. The appliance should now be working normally.

### **The grill works but the top oven does not:**

- \* Check that the top oven door is closing properly.

### **The oven temperature is too high or low:**

- \* Check that the recommended temperatures are being used. Be prepared to adjust the temperature up or down by 10°C to achieve the results you want.

### **The ovens work but the grill does not:**

- \* Check that you have carefully followed the instructions for operation of the grill.
- \* If the cooling fan fails the grill will not operate correctly. Please call your local Service Force Centre.

### **If the oven is not cooking evenly or the side opening door will not stay open:**

- \* Check that the appliance is level.

### **The oven light fails to illuminate:**

- \* The oven light bulb may need replacing.
- \* If the main oven is set for automatic cooking the light will illuminate when the cook time begins.

### **The oven fan is noisy:**

- \* Check that the oven is level.
- \* Check that bakeware and shelves are not vibrating in contact with the oven back panel.

### **The hob burners will not light:**

- \* Ensure the burner parts have been placed correctly.
- \* Check that there is not a problem with your gas supply. You can do this by making sure that other gas appliances such as central heating or gas fire are working.

# SERVICE AND SPARE PARTS

In the event of your appliance requiring service, or if you wish to purchase spare parts, please contact your local Service Force Centre by telephoning:-

**0870 5 929929**

Your telephone call will be automatically routed to the Service Force Centre covering your post code area.

For the address of your local Service Force Centre and further information about Service Force, please visit the website at [www.serviceforce.co.uk](http://www.serviceforce.co.uk)

Before calling out an engineer, please ensure you have read the details under the heading "Something Not Working".

When you contact the Service Force Centre you will need to give the following details:

1. Your name, address and post code.
2. Your telephone number.
3. Clear and concise details of the fault.
4. The model and serial number of the appliance (found on the rating plate).
5. The purchase date.

**Please note that valid purchase receipt or guarantee documentation is required for in-guarantee service calls.**

For Customer Service in Ireland please contact us at the address below:

Zanussi-Electrolux  
Electrolux Group (Irl) Ltd  
Long Mile Road  
Dublin 12  
Republic of Ireland

Tel: +353 (0) 1 4090751

Email: [service.eid@electrolux.ie](mailto:service.eid@electrolux.ie)

## CUSTOMER CARE DEPARTMENT

For general enquires concerning your Zanussi-Electrolux appliance, or for further information on Zanussi-Electrolux products, please contact our Customer Care Department by letter or telephone at the address below or visit our website at [www.zanussi-electrolux.co.uk](http://www.zanussi-electrolux.co.uk)

Customer Care Department  
Zanussi-Electrolux  
55 – 77 High Street  
Slough  
Berkshire  
SL1 1DZ  
Tel: 0870 5 727727 (\*)

\*calls to this number may be recorded for training purposes.

## GUARANTEE CONDITIONS

### Standard guarantee conditions

We, Zanussi-Electrolux, undertake that if within 12 months of the date of the purchase this ZANUSSI-ELECTROLUX appliance or any part thereof is proved to be defective by reason only of faulty workmanship or materials, we will, at our option repair or replace the same FREE OF CHARGE for labour, materials or carriage on condition that:

- The appliance has been correctly installed and used only on the electricity supply stated on the rating plate.
- The appliance has been used for normal domestic purposes only, and in accordance with the manufacturer's instructions.
- The appliance has not been serviced, maintained, repaired, taken apart or tampered with by any person not authorised by us.
- All service work under this guarantee must be undertaken by a Zanussi-Electrolux service centre.
- Any appliance or defective part replaced shall become the Company's property.
- This guarantee is in addition to your statutory and other legal rights.

Home visits are made between **8.30am** and **5.30pm** Monday to Friday. Visits may be available outside these hours in which case a **premium** will be charged.

### Exclusions

**This guarantee does not cover:**

- Damage or calls resulting from transportation, improper use or neglect, the replacement of any light bulbs or removable parts of glass or plastic.
- Costs incurred for calls to put right an appliance which is improperly installed or calls to appliances outside the United Kingdom.
- Appliances found to be in use within a commercial environment, plus those which are subject to rental agreements.
- Products of Zanussi-Electrolux manufacture which are not marketed by Zanussi-Electrolux.

## TECHNICAL DETAILS

### Loading info : Electric ovens

Voltage:	230-240 Volts AC 50Hz
Top Oven:	1.5 kW - 1.7 kW
Grill:	2.5 kW - 2.7 kW
Main Ovens	
Fan Element:	2.3 kW - 2.5 kW
Fan Motor:	0.03 kW
Oven Light:	0.025 kW
Wattage:	4.5 - 4.9 kW

### Loading info : Gas hotplate

	Natural gas	L.P. Gas
L.H.F. – Rapid - injector marking	2.9 kW ( 9895 Btu/h ) 119	2.9 kW ( 208.4 g/h ) 083
L.H.R. / R.H.R. – Normal-injector marking	1.9 kW ( 6483 Btu/h ) 096	1.9 kW ( 136.5 g/h ) 070
R.H.F. – Simmer - injector marking	1.0 kW ( 3412 Btu/h ) 070	1.0 kW ( 71.85 g/h ) 050

### IGNITION

(H.T. Spark) Spark Generator Spark Gap	KIGASS BMS4 3-4mm
--	----------------------

### Physical Characteristics –

Height:	900 mm (nominal)
Width:	600 mm (nominal)
Depth:	600 mm (to front of door panel)
Weight:	67 Kg Net
Gas connection :-	Rear left hand side of appliance at hotplate level Rc 1/2 (1/2" B.S.P. female)
Electrical connection :-	230 - 240 V 50 Hz Mains connected at rear centre of appliance using at least 6mm <sup>2</sup> multi core PVC insulated cable.

### GAS CATERGORY

### COUNTRIES OF DESTINATION

CAT. I<sub>2H</sub>

GB, IE

CAT. I<sub>3+</sub>

GB, IE



This appliance complies with: European Council Directive 73/23/EEC.  
EMC Directive 89/336/EEC.  
CE Marking Directive 93/68/EEC.

# INSTALLATION INSTRUCTIONS

## FOR YOUR SAFETY

Where applicable Natural Gas and L.P Gas versions of this appliance are available. Check that this model is suitable for the type of supply available. In the interest of safety this appliance must be installed and/or serviced by a competent person, as stated in Gas Safety (Installation and Use) Regulations Current Editions. For appliances installed in the Republic of Ireland please refer to NSAI - Domestic Gas Installation IS813 Current Editions.



### WARNINGS:

- This appliance must be installed by a qualified electrician/competent person (CORGI Registered). Safety may be impaired if installation is not carried out in accordance with these instructions.
- **Do not** remove the screws from the earth tab extending from the main oven terminal block (Fig 2).
- Before connecting the appliance make sure that the voltage of your electricity supply is the same as that indicated on the rating plate. This is situated on the lower front frame of the appliance and can be seen upon opening the door. Alternatively the rating plate may also be found on the back or top of some models (where applicable).
- **Do not** alter the electrical circuitry of this appliance.
- **Do not** try to disconnect the appliance from the gas supply if the supply pipe does not have a bayonet connection, as described in the installation instruction. If this is the case contact the person who installed the appliance.



**Warning: This appliance must be earthed.  
Do not earth this appliance to the gas supply piping.**

## CHOICE OF ELECTRICAL CONNECTION

- The appliance should be operated using at least 6mm<sup>2</sup> twin core and earth PVC insulated multicore cable.
- By connecting the appliance to a cooker point having a double pole isolating switch providing at least 3mm contact separation in all poles and protected with a fuse or miniature circuit breaker at your mains fuse box.

**NOTE:** It is good practice to:

- Fit an Earth Leakage Circuit breaker to your house wiring.
- Wire your appliance to the latest IEE regulations.

## THINGS TO NOTE

- If this appliance is to be fitted between cabinets the recommended dimensions as shown in Fig. 1 and the instructions on 'Location of appliance' must be followed.
- Enquiries regarding the installation of the cooker point if required should be made to your Regional Electricity Company to ensure compliance with their regulations.
- The cooker point should be within 2m of the appliance to make it accessible to switch off the appliance in case of an emergency.

### NOTE: HOUSE CIRCUIT

Earth leakage / continuity tests must be carried out before the appliance is connected to the mains supply and rechecked after fitting.

## INSTALLATION INSTRUCTIONS

### IMPORTANT – SAFETY REQUIREMENTS

This appliance must be installed in accordance with the Gas Safety (Installation and Use) Regulations Current Editions and the I.E.E. Wiring Regulations. For appliances installed in the Republic of Ireland please refer to NSAI - Domestic Gas Installation IS813 Current Editions. Detailed recommendations are contained in the following British Standard Codes of Practice – BS.6172, BS.5440: Part 2 and B.S.6891. All British Standards must be 'Current Editions'.

### PROVISION FOR VENTILATION

This appliance is not connected to a combustion products evacuation device. It shall be installed and connected in accordance with the current installation regulations. Particular attention shall be given to the relevant requirements regarding ventilation.

The room containing the appliance should have an air supply in accordance with BS.5440: Part 2 Current Edition. All rooms require an openable window or equivalent and some rooms will require a permanent vent as well. For room volumes up to 5m<sup>3</sup> an air vent of 100cm<sup>2</sup> is required: for room volumes between 5m<sup>3</sup> and 10m<sup>3</sup> an air vent of 50cm<sup>2</sup> is required. If the room has a door that opens directly to the outside, no air vent is required. For room volumes that exceed 11m<sup>3</sup> no air vent is required. If there are other fuel burning appliances in the same room, BS.5440: Part 2 Current Edition should be consulted to determine the requisite air vent requirements.

Prolonged intensive use of the appliance may call for additional ventilation, for example opening a window, or more effective ventilation, for example increasing the level of mechanical ventilation where present.

### MOVING YOUR APPLIANCE

You may damage some soft or badly fitted floor coverings when you move the appliance. The floor covering under the appliance should be securely fixed so it does not ruck up when you move the appliance across it. Alternatively you could remove the floor covering.

To move the appliance open the grill door. Raise the appliance off its front feet by lifting it from inside the oven. Pull the appliance forward. When you replace the appliance push it back to the stop and make sure there is the same gap at each rear corner.

### FOR YOUR SAFETY

**Do not** try to disconnect the appliance from the gas supply if the supply pipe does not have a bayonet connection, as described in the installation instructions. If this is the case contact the person who installed the appliance.

# INSTALLATION INSTRUCTIONS

## LOCATION OF APPLIANCE

This appliance must not be installed in a bed-sitting room of volume less than  $20\text{m}^3$  or in a bathroom, shower room or garage. This is a type 'X' appliance, it is essential that the appliance is positioned as stated below (See Fig 1a) i.e. shelves, wall cabinets and cooker hoods must be fitted a minimum of 787mm directly above the top of the hotplate (or greater for cooker hoods if recommended by manufacturers instructions) and 400mm above the hotplate when fitted in line with the outside of the appliance. If the units are intended to be fitted adjacent to the appliance but less than 400mm above the hotplate, then a minimum space of 100mm must be maintained between the sides of the unit and the appliance (See Fig 1b). Curtains must not be fitted immediately behind the appliance or within 150mm of the sides of the hotplate. If fitted next to or between two base units a minimum space of 1mm must be left between each unit and the sides of the appliance. The levelling feet fitted to the appliance will achieve a nominal height to hotplate trims of  $900\text{mm} + 20\text{mm}$ .

**Note:-** L.P.G. cookers MUST NOT be installed below ground level i.e. in a basement or aboard any boat, yacht or other vessel.

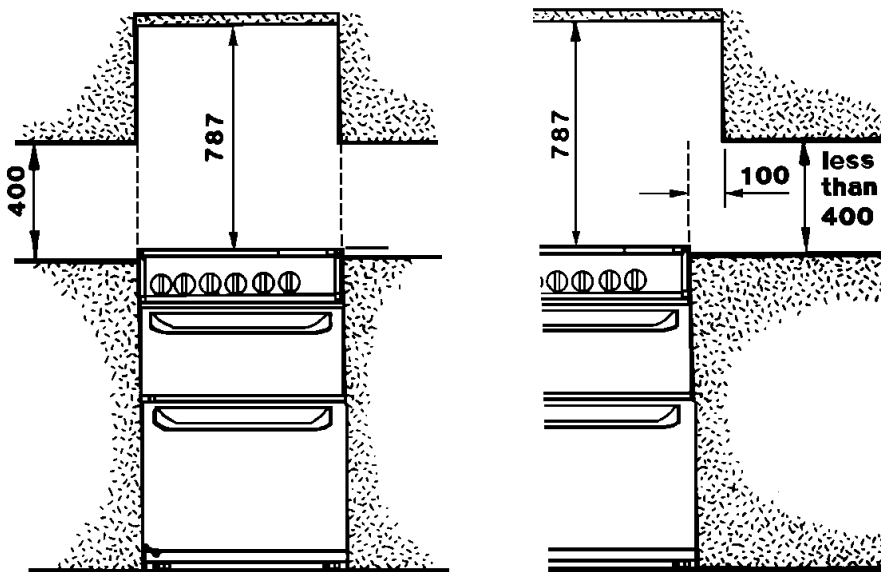

FIG. 1A

FIG. 1B

All dimensions in mm

# INSTALLATION INSTRUCTIONS

## CONNECTING TO THE ELECTRICITY SUPPLY



**Warning: This appliance must be earthed.**  
**Do not earth this appliance to the gas supply piping.**

- We recommend you use a new length of 6mm<sup>2</sup> twin core and earthed cable to ensure your safety.
- Make connection as shown in Fig 2 by proceeding as follows:-
- Preform wires to the appropriate shape to suit fitting into the mains terminal block.
- Strip inner insulation on wires using wire strippers.
- Twist the bared wires using pliers.
- Cut bared wires 10mm away from the end of the inner insulation. Where uninsulated Earth wires are used ensure they are suitably sheathed to leave 10mm bare wire to fit into the terminal.
- Clamp bare wires into the relevant terminal (Fig. 2) and check they are held by tugging each one in turn.
- Clamp the mains cable securely ensuring 5mm of the outer insulation is inside the terminal block and that the wires are not taught but not so slack as to cause any fouling.
- Connect the remaining end of the mains cable to the appliance to the appliance point / junction box.
- Place fuse / miniature circuit breaker in circuit and switch on at mains.

### NOTE: HOUSE CIRCUIT

Earth leakage / continuity tests must be carried out before the appliance is connected to the mains supply and re-checked after fitting.

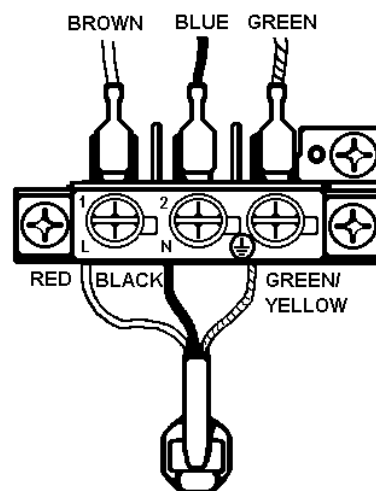

FIG.2.



## INSTALLATION INSTRUCTIONS

### CONNECTING TO GAS SUPPLY

This appliance is designed to be installed with an appliance flexible connection only. Supply piping should not be less than R<sup>3</sup>/8. Connection is made to the Rc 1/2 (1/2" B.S.P.) female threaded entry pipe located just below the hotplate level on the rear left hand side of the appliance. **NOTE: ONLY LIQUID SEALANTS TO BE USED WHEN INLET GAS PIPE IS FITTED I.E.: DO NOT USE P.T.F.E. SEALANT TAPE.** Carry out a gas tightness test after connecting to the gas supply. The gas bayonet connector must be fitted in the shaded area indicated in Fig.3. Take into account that it must be possible to pull the appliance forward sufficiently. The hose must not get caught on the stability bracket.

**IMPORTANT: FLEXIBLE TUBING USED MUST COMPLY WITH BS.669 CURRENT EDITION.**

LPG Flexible connections must be a type suitable for L.P.G and capable of operation up to 50 mbar and carry a red stripe, band or label.

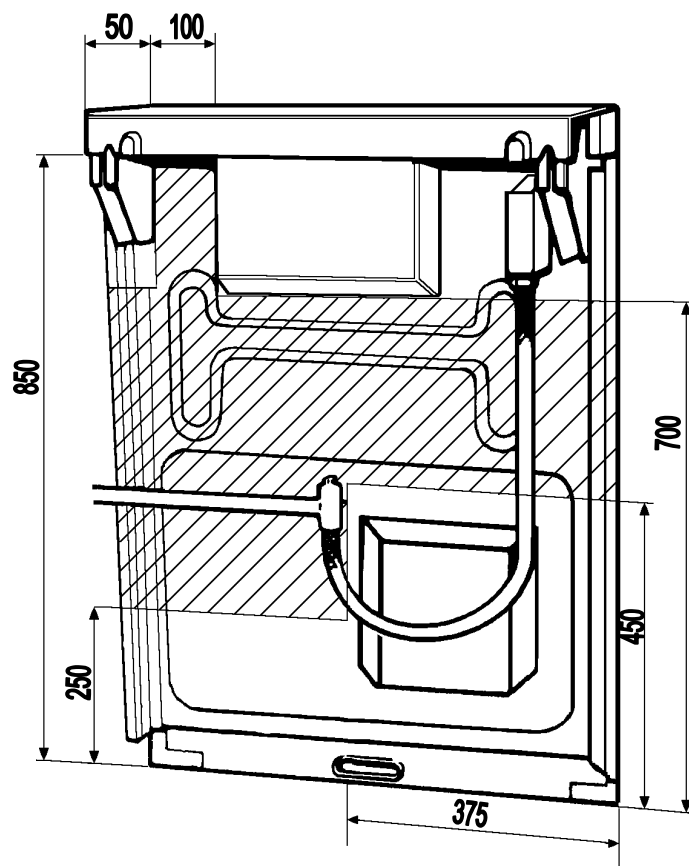

Fig. 3

## INSTALLATION INSTRUCTIONS

### FITTING THE STABILITY BRACKET

It is recommended that if the appliance is to be installed with a flexible supply pipe, a stability bracket (SK.4729.A) is fitted, and is available from your supplier (see Important Safety Requirements). These instructions should be read in conjunction with the leaflet packed with the stability bracket.

1. Place the appliance in its intended position and level appliance.
2. Mark off 300mm from the left hand side of the appliance as shown in dimension 'A' Fig.4a. This is the centre line of the fixing bracket.
3. Draw a line from the front edge of the feet (see Fig.4a) and remove appliance from its position. Mark off dimension 'B' (see Fig.4a) back from this line on the centre line of the bracket to locate the front edge of the lower bracket. Fix lower bracket (with two fixing holes) to the floor then measure the height from floor level to engagement edge on back of appliance, dimension 'C' of Fig. 4b.
4. Assemble upper bracket to lower bracket so that the underside of bracket is dimension 'C' + 3mm above floor level. (See Fig. 4b)

Reposition appliance and check that top bracket engages into appliance back as shown in Fig. 4b.

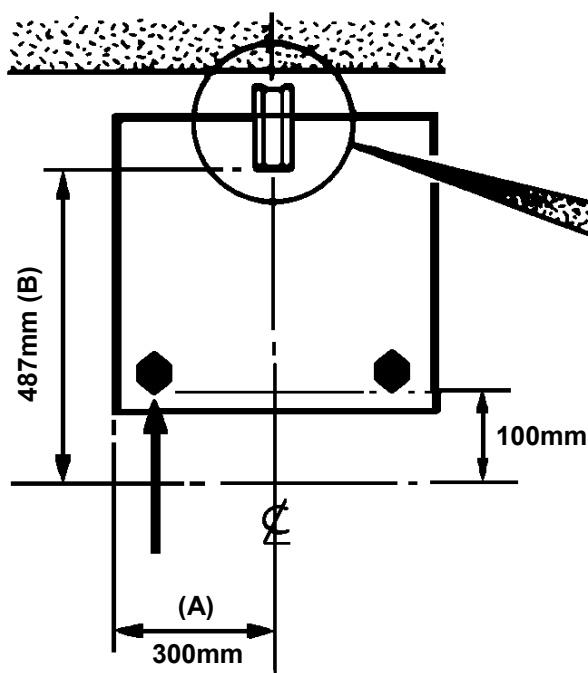

Fig.4a.

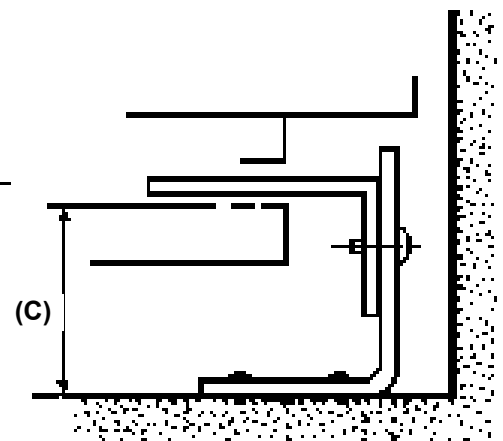

Fig.4b.

# INSTALLATION INSTRUCTIONS

## PRESSURE TESTING

1. The Rapid injector is used as a pressure test point.
2. Connect the pressure gauge to the Rapid injector.
3. Check the supply pressure by turning the Rapid burner on and one other hotplate burner full on and light the appropriate burner. The pressure should be either:-
  - (i) For Natural Gas 20mbar
  - (ii) For LP. Gas. The pressure must be set to 28 mbar for use on butane or 37 mbar for use on propane.
4. Turn off the taps, disconnect the pressure gauge.
5. Check operation of each hotplate burner.

## CHECKING THE GRILL

Place the grill pan containing the grid into the grill compartment. Open the grill door and turn the grill control to full on. Visually check that the element is heating up.

## CHECKING THE HOTPLATE

Fit the burner crowns and caps ensuring that they are correctly seated. Fit the pan supports. Check each of the hotplate burners in turn by turning the hotplate tap to its full on position and pushing the ignition button. As soon as the burners are lit the button can be released.

## TO SET THE TIME OF DAY

To set the clock (See Fig.5).

1. Turn on electricity supply and ensure that the thermostat is in the off position.
  - 1a. Before setting timer read important note below.
2. Rotate the left hand clock knob to 'Manual' and back to the 'Clock' position.
3. Set the time of day by rotating the right hand knob. Note that it is a 24 hour clock.
4. Rotate the left hand clock knob back to the 'Manual' position.

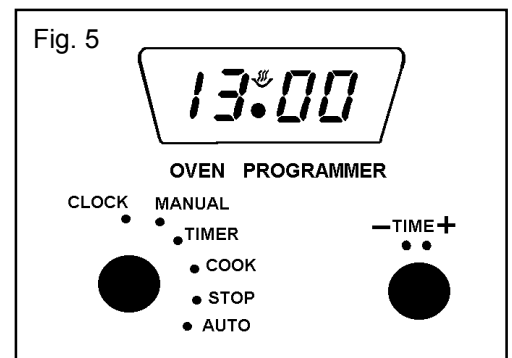

**NOTE:** When setting the time of day with the knob in the 'Clock' position only, this will activate the timer for seven seconds after selection. This means that when setting the time of day in this function the timer can only be set by using the right hand knob within a seven second period. After seven seconds have elapsed from when the correct time of day has been set, the timer ceases to be active and subsequent operation of the right hand knob will not change the clock.

## **INSTALLATION INSTRUCTIONS**

### **CHECKING THE MAIN OVEN**

1. Ensure the timer is set to manual operation.
2. Turn on the main oven thermostat to the highest setting.
3. Ensure the oven is heating up by checking firstly that the oven neon illuminates.
4. After a short period the heat from the oven element may be felt with the oven door open.
5. Check that the oven light and oven fan are functioning.

### **CHECKING THE SECOND OVEN**

1. Ensure the timer is set for manual operation and the oven door is closed.
2. Turn on the second oven thermostat to the highest setting.
3. Ensure the oven is heating up by checking firstly that the oven neon illuminates.
4. After a short period the heat from the oven element may be felt with the oven door open.
5. Check that the oven light is functioning.

### **GENERAL NOTE**

Instruct the user on how to use the appliance and its ignition system. Refer the user to the wording on the inside cover which gives advice on the safe operation of the appliance.

## NOTES

## NOTES

## NOTES

## IMPORTANT NOTICE

In line with our continuing policy of research and development, we reserve the right to alter models and specifications without prior notice.

This instruction booklet is accurate at the date of printing, but will be superseded if specifications or appearance are changed.

ZANUSSI-ELECTROLUX  
55 – 77 HIGH STREET,  
SLOUGH,  
BERKSHIRE,  
SL1 1DZ  
TELEPHONE 0870 5 727727  
[www.zanussi-electrolux.co.uk](http://www.zanussi-electrolux.co.uk)  
Part Number: 311698100

© Electrolux plc 2003

 **From the Electrolux Group.** *The world's No.1 choice.*

*The Electrolux Group is the world's largest producer of powered appliances for kitchen, cleaning and outdoor use. More than 55 million Electrolux Group products (such as refrigerators, cookers, washing machines, vacuum cleaners, chain saws and lawn mowers) are sold each year to a value of approx. USD 14 billion in more than 150 countries around the world.*